



United Technologies
turn to the experts

i-Vu® Standard/Plus v6.0 Installation and Start-up Guide





Verify that you have the most current version of this document from www.hvacpartners.com or your local Carrier office.

Important changes are listed in **Document revision history** at the end of this document.

CARRIER CORPORATION © 2014. All rights reserved throughout the world. i-Vu is a registered trademark of Carrier Corporation. BACnet is a registered trademark of ASHRAE. All other trademarks are the property of their respective owners.

Contents

What is the i-Vu® Standard/Plus v6.0 application?.....	1
i-Vu® tools.....	2
What's new in v6.0	3
What's new in the i-Vu® Standard/Plus v6.0 application.....	3
Before starting the i-Vu® application and your system.....	7
Step 1: Install Tools and have documentation ready.....	7
Step 2: Install device managers and routers	7
Step 3: Use Network Service Tool V to ensure hardware is communicating on the CCN network.....	8
Step 4: Get your systems ready.....	9
Starting up an i-Vu® Standard/Plus web server	10
Connect and power up web server	10
Access the startup screen	12
Configure i-Vu® IP addresses	14
Configure the i-Vu® system using static IP addresses	14
Management Tool	15
Set up login and passwords for an additional user	16
Operators tab.....	17
Setting up i-Vu® client devices and web browsers	19
Setting up and using a computer with the i-Vu® system.....	20
Using a tablet with the i-Vu® system	20
Setting up and using a web browser to view the i-Vu® interface	22
To set up and use Internet Explorer	22
To set up and use Mozilla Firefox.....	23
To set up and use Google Chrome	24
To set up and use Safari.....	26
Troubleshooting.....	27
If using DHCP and can't access the i-Vu® web server with Internet Explorer, by computer name	27
i-Vu® web server connected to computer with a crossover cable	27
i-Vu® device plugged into LAN	28
Example 1: Determining if a valid Ethernet connection exists	29
Example 2: Determining if Internet Explorer is using a proxy server.....	30
Example 3: Pinging by computer name	31
Example 4: Adding exceptions to a proxy server in Internet Explorer	31
DVI to VGA converter	32
System Management	33
Backup data from Management Tool	33
Restore data from backup	34
Restore factory defaults	34
Restore i-Vu® system	34
Update the equipment library.....	35
Synchronize to system time.....	37
Advanced topics.....	38
i-Vu® connection options and requirements.....	38
Using a loopback address	41
If DHCP will not assign two IP addresses	41
Finding the MAC address of the i-Vu® web server	42
Using TCP/UDP ports	43
Communicating using PuTTY	43
Communicating using HyperTerminal	45
Document revision history	48

Contents



What is the i-Vu® Standard/Plus v6.0 application?

An i-Vu® system is a web-based building automation system that can be accessed from anywhere in the world through a web browser, without the need for special software on the workstation. Through the web browser, you can perform building management functions such as:

- adjust setpoints and other control parameters
- set and change schedules
- graphically trend important building conditions
- view and acknowledge alarms
- run preconfigured and custom reports on energy usage, occupant overrides, and much more

In addition to all the functions that the i-Vu® Standard application supports, the i-Vu® Plus application supports:

- Third party integration
- Advanced custom reporting
- Tenant Override Billing
- Web Services (XML/SOAP)
- Controllers attached to the i-Vu® Link or i-Vu® Open Link

i-Vu® v6.0 systems may consist of:

- i-Vu® web server
- The following routers:

i-Vu® Standard

- USB CCN Adapter or USB Open Adapter
- i-Vu® CCN Router
- i-Vu® Open Router

i-Vu® Plus

- USB CCN Adapter or USB Open Adapter
- i-Vu® CCN Router
- i-Vu® Open Router
- i-Vu® Link
- i-Vu® Open Link
- Controllers associated with each router or with the USB Adapter

NOTE The i-Vu® Standard/Plus v6.0 application allows a maximum of 750 controllers, 60 per Open router or the USB Open Adapter, and 140 CCN controllers per device manager or USB CCN Adapter.

i-Vu® tools

Develop and configure graphics and a system database for your i-Vu® system using the following i-Vu® tools.

NOTE The i-Vu® v6.0 tools have a built-in license that expires 2 years after the software is released. Contact Carrier Control System Support for updates concerning your license.

Use...	To...
ViewBuilder	Create or edit graphics

Tech tools for the Installer only:

Use...	To...
EquipmentBuilder	Build or edit control programs (.equipment files) for programmable controllers. Can also produce graphics, sequence of operation, and screen files
Alarm Pop-up	Receive a message on any networked computer that is running the i-Vu® Alarm Notification Client application
Virtual BACview®	View and change property values and the controller's real time clock
BBMD Configuration Tool	Configure BACnet/IP Broadcast Management Devices (BBMDs) NOTE If your system has multiple routers that reside on different IP subnets, you must set up one router on each IP subnet as a BACnet/IP Broadcast Management Device (BBMD).
MSTP Capture Utility	Capture BACnet traffic on MS/TP. It is intended for use in situations where Carrier Control Systems Support needs a network capture to troubleshoot communications.
Test & Balance	<ul style="list-style-type: none"> • Calibrate airflow in a VAV or VVT Zone controller • Calibrate the static pressure in a VVT Bypass controller • Commission air terminals • Override reheat and terminal fans <p>NOTE Use Test & Balance to manipulate the controllers associated with an air source, but not the air source itself, or heating and cooling equipment, such as chillers and boilers.</p>
Snap	Build custom control programs using individual blocks of programming code called microblocks
LonWorks Integration Tool	Generate the microblock addresses automatically for third-party LonWorks points
AppLoader	Use to download .clipping files to restore factory defaults and check Module Status (Modstat) via the Rnet port
Field Assistant	Service or start up and commission a piece of equipment or a network of controllers.

What's new in v6.0

What's new in the i-Vu® Standard/Plus v6.0 application

Feature	Improvement															
New look	The i-Vu® interface has been updated.															
<i>Supports multiple web browsers</i> (page 19)	<p>An i-Vu® Standard or Plus system can now be viewed through the following web browsers on a computer with a Windows®, Linux®, or OS X® operating system:</p> <ul style="list-style-type: none"> • Internet Explorer® v8 or later • Mozilla® Firefox® v19.0 or later • Safari® v6 or later (Mac only) • Google™ Chrome™ v23.0 or later <p>NOTE i-Vu® v6.0 no longer supports Internet Explorer 6 or 7.</p>															
<i>Tablet support</i> (page 20)	<p>You can now view and control your i-Vu® system on tablets that have the following operating systems and web browsers.</p> <table border="1"> <thead> <tr> <th>Operating system</th> <th>Web browser</th> <th>Tested tablet*</th> </tr> </thead> <tbody> <tr> <td>iOS</td> <td>Safari®</td> <td>Apple® iPad®</td> </tr> <tr> <td>Windows® RT</td> <td>Internet Explorer® 10 or Metro-style Internet Explorer® 10</td> <td>Microsoft® Surface™</td> </tr> <tr> <td>Windows® 8 or 8.1 Pro</td> <td>Internet Explorer® 10/11 or Metro-style Internet Explorer® 10/11</td> <td>Microsoft® Surface™ Pro</td> </tr> <tr> <td>Android™</td> <td>Google™ Chrome™</td> <td>Google™ Nexus™ 7 and 10</td> </tr> </tbody> </table> <p>* Touch functionality of tablets not tested by Carrier may or may not work for i-Vu® use. Use at your own risk. Click here (page 20) for information on tablet behavior and limitations.</p>	Operating system	Web browser	Tested tablet*	iOS	Safari®	Apple® iPad®	Windows® RT	Internet Explorer® 10 or Metro-style Internet Explorer® 10	Microsoft® Surface™	Windows® 8 or 8.1 Pro	Internet Explorer® 10/11 or Metro-style Internet Explorer® 10/11	Microsoft® Surface™ Pro	Android™	Google™ Chrome™	Google™ Nexus™ 7 and 10
Operating system	Web browser	Tested tablet*														
iOS	Safari®	Apple® iPad®														
Windows® RT	Internet Explorer® 10 or Metro-style Internet Explorer® 10	Microsoft® Surface™														
Windows® 8 or 8.1 Pro	Internet Explorer® 10/11 or Metro-style Internet Explorer® 10/11	Microsoft® Surface™ Pro														
Android™	Google™ Chrome™	Google™ Nexus™ 7 and 10														
CCN and Open systems merged in one front end	The i-Vu® application now supports both CCN and Open systems simultaneously. You can use a USB Adapter for either one, but not both.															
i-Vu® Standard and Plus support CCN and Open devices	<p>The i-Vu® Standard and Plus application now support a maximum of</p> <ul style="list-style-type: none"> • 750 controllers total • 140 CCN controllers per device manager or USB CCN Adapter • 60 Open controllers per Open router or USB Open Adapter 															

Feature	Improvement
Devices page	<p>A new page that allows you to:</p> <ul style="list-style-type: none"> • Connect to your CCN and Open systems • View network/controller communication status • Resolve database/controller mismatches • View controller information such as model, address, driver, and control program • Find Carrier devices on a network that are not in your system database
Find CCN device managers and controllers	<p>To populate your i-Vu® interface with your CCN system, select the site level in the navigation tree, go to Devices > CCN Setup to connect to Gateway. Then, select the Gateway in the navigation tree and scan for CCN devices.</p>
Find Open routers and controllers	<p>To populate your i-Vu® interface with your Open system, go to Devices > Manage tab. This takes the place of Discover > Setup tab.</p>
Downloading	<ul style="list-style-type: none"> • You can download from the new Downloads page or the Devices > Manage tab. • The Downloads page provides flexibility and feedback on the download tasks. • You can download up to 5 routers simultaneously. • The download option called All Content includes all source files (.equipment., .view, .bacview, .touch, and .driver). Using this information, the new Devices page can show file discrepancies between the database and controller. • You can see who downloaded a controller on the Controller Status Report.
Download CCN	<p>You must now download after making changes to a CCN controller by clicking the Download CCN button on Devices > Manage tab. CNN changes used to download automatically.</p>
Optimize upload	<p>The i-Vu® application now installs with a directory of factory PIC files. When you Find Devices in the i-Vu® interface, the server checks the factory_applications directory against the files in the controller. If they match, the server copies the source from the directories, rather than uploading the files from the controller. This saves a considerable amount of time.</p>
Source files	<p>You can import or export source files (.equipment., .view, .bacview, .touch, and .driver) from System Options > General tab > Source Files section.</p>
Clippings	<p>You can import or export clipping files from System Options > General tab > Clippings section. Clippings include the entire database. You can use clippings to combine existing systems.</p>
Optional time-saving Download settings	<p>In the System Options > General tab > Download section, there are 2 selectable options:</p> <ul style="list-style-type: none"> • Optimize download for Open PIC controllers - does not download full source - enabled by default • Include graphics in Open programmable controller download - you can uncheck this to save time when downloading custom control program files, if the graphics have not been edited
Properties page > Network Points tab	<p>The Com Enabled column has a new All checkbox to let you quickly enable/disable all points in the control program.</p>

Feature	Improvement
Import/Export calibration data	You can export I/O point calibration data from a control program and import it into the same control program or another control program with the same I/O point configuration.
<i>Update library version warning message</i> (page 35)	When updating the SAL library, if the controller has a newer version than the one you are updating to, a warning message appears and allows you to select the desired library.
BACnet® Discovery	This feature is on the Devices > Advanced tab. You can now export the BACnet information to a .discovery file that can be opened in Snap. NOTE Available ini-Vu® Plus v6.0 only.
Debug mode	Saves downloading time when troubleshooting custom control programs.
Automatically download schedules as you create them	This field has moved from the Schedules > Configure tab to the System Options > My Settings tab because it is a user choice.
Advanced Password Policy	The System Settings > Security tab has new options: <ul style="list-style-type: none"> • Cannot be changed more than once every__ days • Force expiration button
Alarms	The Alarms View interface has the following improvements: <ul style="list-style-type: none"> • Collapsible sections for Alarm management and View filter options. • Navigate forward and backward 50 alarms at a time and scroll within the 50 currently displayed • Acknowledge, delete, or force normal apply to all selected alarms. • Single-click to expand an alarm instead of double-click. • The alarm category icons have been updated.
Email alarm action	If an Email alarm action is to attach a report, the file name of the attached report will now include the report name, date, and time. For example, Alarm Sources 2012 Jan 01 1230 .
Alarm Notification Client	It now has a continuous sound and silencing feature. Enable support for Alarm Popup clients on the System Settings > the General tab.
Schedules	The Schedules interface has been revised for improved usability.
CCN Schedules tab	Systems with a CCN Gateway have a CCN tab for the Schedules page that shows any CCN schedules at or below the selected tree location.
Schedule Group folders	You can create folders and sort your groups into them to organize the Scheduling Groups tree.
Group tree changes in the audit log report	Previously, group tree changes were not captured in the audit-log. They can now be included or excluded in the system level audit log report.
Trends	The Trends interface has been revised for improved usability and multiple web browser support.
Saving report designs	You can now save the design of an Equipment Values or Trend Samples report for reuse in another location or another system.

Feature	Improvement
Deleting custom reports and trend graphs	Instead of using the Delete option on the i-Vu® menu, you now: <ul style="list-style-type: none"> • Click the Delete Report button on the report's Design tab. • Click the Delete Trend Graph button on the trend graph's Configure tab.
Guest operators	Operators assigned the Guest role cannot edit their Login Name, Password, or other preferences on the System Options > My Settings tab.
System Options	Some fields have been moved to another tab, and some tabs have been restructured to improve usability.
System Options > Add-ons	The Web Applications tab has been renamed to Add-ons and redesigned. NOTE Applies to the i-Vu® Plus interface only.
Time Sync	Both Open and CCN controllers are updated when you Enable Time Synchronization of controllers daily.... on the System Options > General tab or click the Time Sync button.
<i>Network Time Protocol</i> (page 15)	Network Time Protocol (NTP) is a networking protocol for clock synchronization. In the Management Tool , you can designate an NTP source that delivers the correct time to the i-Vu® web server, ensuring constant accurate time.
Support for new ZS Sensors	New ZS Sensor control on equipment graphics The equipment Properties page has an Rnet Points tab showing microblocks that have Rnet enabled.
Interactive Zone Sensor control for ZS Sensors	The new ZS Sensor Interactive Zone Sensor on an equipment graphic allows setpoint adjustment and override of an unoccupied state.
Touchscreen files	The i-Vu® application now supports .touch files for the new touchscreen.
Adjustable Arrange User View window	The Arrange User View window can be resized.
Updates	Update and Update Library are now a single tab in System Options and show lists of the updates that have been installed, grouped by update type. You can now use the Update tab to update all drivers, Help, patches, service packs, and the SAL library.
Password security	Password security has been enhanced. If the i-Vu® application is v6.0 and an Alarm Notification Client (ANC) is an earlier version, clicking the button in ANC that opens the i-Vu® interface will require you to log in.
License expiration	The Customer and Tech Tools applications come with an embedded license that is in effect until 2 years after the software release date. You must contact your Carrier representative to renew your license when it expires.
Security enhancement	Apache Tomcat web server has been upgraded to v7.0.30
Java	The i-Vu® application has been upgraded to Java 7.
bacnet showindex manual command	This new command shows all files (file name, size, date) downloaded to the selected controller.

Before starting the i-Vu® application and your system

NOTE These instructions are typically for a computer with a Microsoft® Windows 7 operating system. If you have a different operating system, some instructions may vary slightly. See your operating system's Help for more information.

You must complete the following steps BEFORE powering up the i-Vu® web server!

Step 1: Install Tools and have documentation ready

- 1 Insert the **Tech Tools** DVD into your computer and wait until the Installation screen appears. If this screen does not appear, open **My Computer** and double-click **Tech Tools**.
- 2 Click the utilities you wish to install. Depending on how security and permissions are configured on your Windows computer, you may need to right-click the executable file and select **Run as Administrator**. For example, to install Tech Tools, right-click **i-Vu_Tools_6.0_windows_setup.exe** and select **Run as Administrator**.

NOTES

- Some utilities such as the BBMD tool and BACScope are not installed on the hard drive, but run directly from the DVD.
 - Documentation is not copied to the hard drive. We recommend that you copy the **Tech Tools** DVD to a folder on your hard drive. This ensures that you have the documentation and utilities when you need them.
- 1 Print the the i-Vu® Owner's Guide.
 - 2 Follow the rest of this document to set up your entire system.

Step 2: Install device managers and routers

If you haven't already, download the *Installation and Start-up Guides* for the i-Vu® CCN Router, i-Vu® Link, i-Vu® Open Router or i-Vu® Open Link from the *Carrier Control Systems Support Site* <http://www.hvacpartners.com/>.

You need the instructions in those documents to:

- Mount and wire your CCN device manager(s) or Open router(s)
- Wire the ports for communication and set DIP switches
- Set up IP addressing, including BACnet/IP Broadcast Management Devices (BBMDs)

NOTE If your system has multiple routers that reside on different IP subnets, you must set up 1 router on each IP subnet as a BACnet/IP Broadcast Management Device (BBMD's).

- Configure BACnet device instance and network number using PuTTY or Hyperterminal connected to the Rnet or S2 port. See *Communicating using PuTTY* (page 43) or *Communicating using Hyperterminal* (page 45).

Step 3: Use Network Service Tool V to ensure hardware is communicating on the CCN network

- 1 Connect the 3-terminal connector of the Network Service Tool's **USB to CCN Converter** to Port **S1** on the i-Vu® device manager.

Carrier USB to CCN converter (top CCN Port)	i-Vu® device manager (Port S1)
+	Net+ (Pin 1)
G	Signal Ground (Pin 5)
-	Net- (Pin 2)

- 2 Launch **Network Service Tool** and connect to the i-Vu® device manager. Each i-Vu® device manager defaults to Gateway functionality and has a CCN address of **0, 1**.



CAUTION Every CCN device must have a unique CCN address on the CCN network! Do not use Bus **0**, Element **238**, as it is automatically assigned to the i-Vu® web server.

- 3 Find the device manager at 0,1 using **Address Search** and change the device manager's CCN address as desired.

NOTE We do not recommend leaving a device manager's CCN address at 0,1, because this is the address that it defaults to when formatted.

- 4 Upload the i-Vu® device manager.

- 5 Access the **Service Configuration Table** IP_CONF to enter the following configuration options:

NOTE A static IP address is required, as DHCP is not supported.

- **Host IP Address** - enter the device manager's IP address, provided by the LAN administrator (allowable entries for xxx.xxx.xxx.xxx: xxx is a decimal number between 0 - 255)
- **Subnet Mask** - enter the device manager's IP address, provided by the LAN administrator (allowable entries for xxx.xxx.xxx.xxx: xxx is a decimal number between 0 - 255)
- **Default Gateway** - enter the IP Gateway's IP address, provided by the LAN administrator (typically a router on the Ethernet LAN).

CCN ENET Configuration

Device Type

- Select **0** if this device manager is the Gateway. (**NOTE** Only 1 Gateway is permitted per system.)
- Select **1** if this device manager is the Bridge.

If using the router as a Bridge, enter **CCN/Ethernet Gateway IP** (the IP address of the i-Vu® device manager that is configured as the Gateway). This is the same address that was entered in the **Host IP address** for the CCN Gateway.

NOTE Record the IP address of the Gateway, because you need it to install your i-Vu® system.

- 6 Repeat the above steps for every i-Vu® device manager used in the CCN system.

Step 4: Get your systems ready

CCN

- 1 Have the IP address of the external Gateway, if you are not using the USB CCN Adapter.
- 2 Have a list of all of the devices at your job site, along with the name of each device, the bus and element numbers, and their respective locations.
- 3 For a retrofit project, which is already using CCN global and network schedules, you must have a list of all existing CCN schedule numbers, systems using global and network schedules, and all global schedule masters.
- 4 Verify that each device has a unique element number because duplicates will not install correctly.



CAUTION Do not use Bus 0, Element 238. It is automatically assigned to the i-Vu® web server.

BACnet

- 1 Create a list of all of the i-Vu® Open routers and controllers at your job site, with their BACnet Device ID's, IP addresses (where applicable), BACnet network numbers, and the physical location of all devices.
- 2 Verify that every router has a unique address because duplicates will not install correctly.

Consult i-Vu® Help for more information about setting schedules in the i-Vu® interface.

Starting up an i-Vu® Standard/Plus web server

Use the following procedures, which are explained in detail below.

- 1 *Connect and power up the i-Vu® web server* (page 9).
- 2 *Access and fill out the startup screen* (page 12).
- 3 *Configure your IP addresses in the Management Tool* (page 14).
- 4 *Set up login and password for other users* (page 16).

Connect and power up web server

CAUTION!

- Mount your i-Vu® web server in an air conditioned space to avoid damage.
- Do NOT open the i-Vu® web server! Opening the web server voids your warranty.

- 1 Plug the power cable into the back of the i-Vu® web server and into an electrical outlet.

NOTE We highly recommended using a UL Certified power surge/RFI suppression device.

- 2 Connect an Ethernet cable from the laptop, computer's network port, or the customer's LAN, to the Ethernet jack on the back of the i-Vu® web server.

NOTE Your computer must be configured for DHCP if connecting directly to the i-Vu® web server.



- 3 If you are using the USB Adapter (CCN or Open) to connect to your network, plug the adapter into the USB port and connect to your network. You can only use one adapter on the web server.

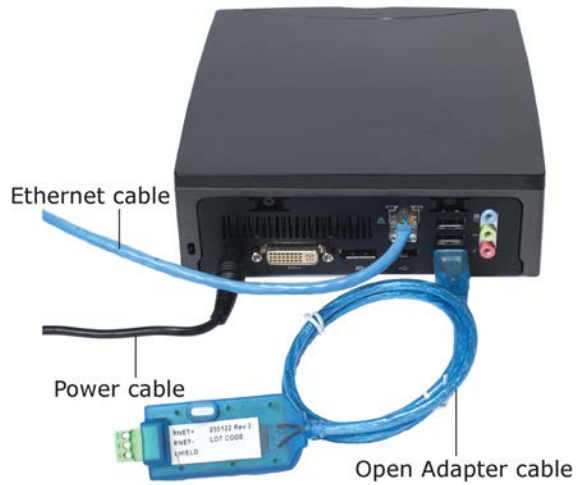
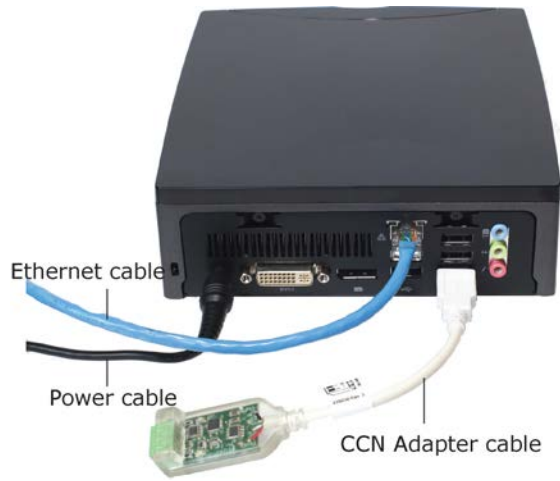

- 4 Press the **On/Off** Button to turn on the i-Vu® web server.



Access the startup screen

NOTES

- Use only the i-Vu® interface to navigate through the i-Vu® application; do not use the browser's navigation buttons.
 - Disable all popup blockers. **Internet Explorer > Tools > Popup Blocker**, Google, and Yahoo Toolbars, etc.
- 1 Launch the browser and type **http://ivu** to reach the startup screen. If i-Vu®'s startup screen does not appear, see *Troubleshooting* (page 27).
 - 2 Accept the terms of the License Agreement and click **Next**.
 - 3 Fill in all required fields:

Create Installer Account

- **Login Name** - not case sensitive, accepts spaces and special characters
- **Password** - set as desired

System Settings

Network Name

- Controls the name used to access your system from the Internet or network (LAN)
- Is case sensitive and should not contain special characters or spaces
- If you change the network name from "ivu", make note of the change in the i-Vu® Owner's Guide

System Name

- Enter your organization/building name; this becomes the top level in the navigation tree.
- This can be changed later from the Installer view in the **Arrange User View** window.

USB Network Type

- Enter the type of network connection you are using. If you are using a USB Adapter, make sure that it is plugged into the web server and that you select the CCN or BACnet option.

If you decide to use a USB CCN or BACnet adapter at a later date, after your system is configured without one:

USB CCN adapter - Requires restoring your system to factory defaults, which results in losing all your system data.

- **USB BACnet adapter** - Your data is not lost, however, you must restart the web server after the adapter is plugged in. If you have both external Open routers and the USB BACnet adapter, and the USB Network Address is using an internal loopback address of 127.0.0.1, you must assign a new IP address to the USB Network Address in the Management Tool and then restart the web server.

Regional Settings

- o **Timezone, Date** - select appropriate options
- o **Time** - enter the correct time! The i-Vu® web server will **not** automatically read the time from your computer.

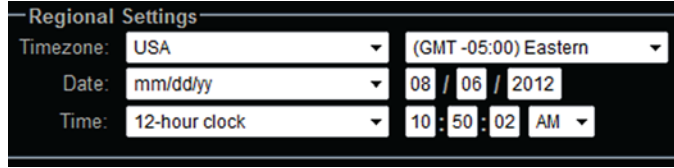

Regional Settings

Timezone: USA (GMT -05:00) Eastern

Date: mm/dd/yy 08 / 06 / 2012

Time: 12-hour clock 10 : 50 : 02 AM

- 4 Click **Next**.
- 5 Review entries. Click **Submit**. Wait for your system to launch. It will take a minute. If you get an error, type http://<your system name> in your browser and hit return. Click **Next**.
- 6 The Welcome page provides basic instructions to get started. Refer to Help  in the i-Vu® interface for detailed instructions on navigating, finding your routers and controllers, configuring properties, trends, alarms, reports, and much more.

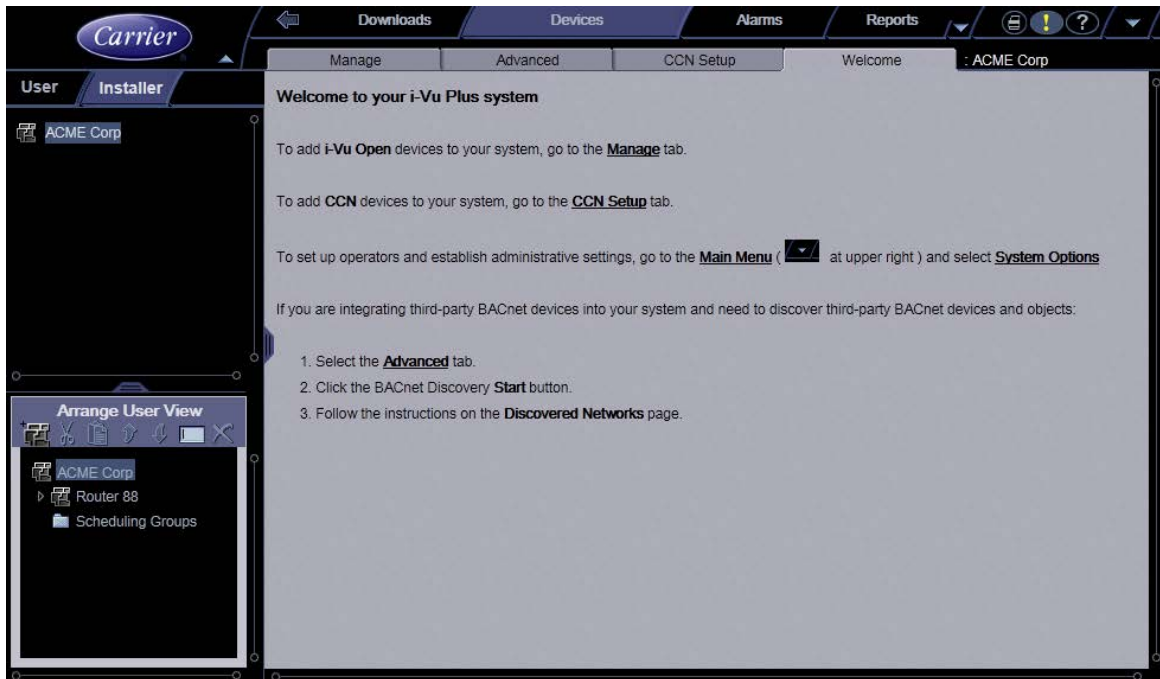

Configure i-Vu® IP addresses

The i-Vu® application is set by default to automatically obtain its IP configuration information using DHCP. Once the i-Vu® web server is initially started up, you can connect it to a building LAN that supports DHCP (assuming a DHCP server is available). If the site requires a static IP address for the i-Vu® web server, this information should be provided by the customer and must be assigned to the i-Vu® web server in the *Management Tool* (page 15).

NOTES:

- If you need to assign your own IP addresses, see *Configure i-Vu® using static IP addresses* (page 14).
- If you are having problems with a DHCP Server that will not assign two IP addresses to one network card or MAC address, see *If DHCP will not assign two IP addresses* (page 41).
- If using a loopback address, refer to *Using a loopback address* (page 41) for important details.

Configure the i-Vu® system using static IP addresses

NOTE If using a loopback address, refer to *Using a loopback address* (page 41) for important details.

- 1 In the i-Vu® interface, open the Management Tool by clicking **Main Menu** , then selecting **System Options** > **General** tab > **Management Tool**, or through your browser by typing your system name or IP address followed by :8080
For ex.: http://ivu:8080, http://<ip address>:8080 http://<networkname>:8080
- 2 If it is the first time you are accessing the Management Tool, enter your name and password.
- 3 Remove the check by **Obtain an IP address automatically** and enter the **I-Vu Address**, **Subnet Mask**, and **Default Gateway**.
- 4 Enter the **DNS Address**.
- 5 You must enter a fully qualified domain name in the **Domain** field if you want the i-Vu® application to be able to email alarms. Otherwise, you can leave the field blank.
- 6 Enter a **USB Network Address**.

NOTE You may use an internal loopback address of 127.0.0.1 in this field only if a USB Adapter **or** external routers are used. If you use both the USB Adapter and external routers, the loopback address should not be assigned to the **USB Network Address**. Instead, configure the **USB Network Address** with an appropriate IP address for the subnet that the i-Vu® web server is on.

- 7 If NTP is enabled, enter NTP server addresses. See *Management Tool* (page 15) for detailed instructions.
- 8 Click **Apply Changes**.

NOTE If the i-Vu® web server was connected directly to a computer when configured, applying changes in the Management Tool will most likely result in the computer being on a different IP subnet than the i-Vu® web server. In this case, the connection to the i-Vu® web server will be lost. To regain communication with the i-Vu® web server, you must configure the IP address of the computer to be on the same subnet.

Management Tool

You can access **Management Tool** by either:

- Clicking **System Options > General** tab > **Management Tool** button
- Launching your browser and typing your system name followed by **:8080**. For ex.: http://ivu:8080/

NOTE The **Management Tool** is password-protected and can only be accessed by a user with **Installer** role.

System Status

i-Vu is running at:	This is used to troubleshoot server or LAN communications. Click the Stop Server button to stop the i-Vu® web server. When stopped, the button changes to Start Server . Do NOT close the Management Tool before restarting the server. Click to restart.
Weekly system logs:	<ul style="list-style-type: none"> • System - used for troubleshooting (same as logs available from System Options > General tab). Logs are available for a maximum of 4 weeks. • Kernel - operating system logs
Addressing	 CAUTION If you change the name or the IP address of your system, record the numbers in a secure place. <ul style="list-style-type: none"> • Name - Controls the name used to access your system from the Internet. Do not use special characters or spaces. • Obtain an IP address automatically - Uncheck this to manually assign addresses for the following: <ul style="list-style-type: none"> ○ i-Vu Address ○ Subnet Mask ○ Default Gateway ○ DNS Address - IP address of the Domain Name Server ○ Domain - Host name of the domain (i.e. carrier.utc.com) ○ USB Network Type - Read-only field shows either CCN or BACnet types. ○ USB Network Address - IP address of the internal BACnet router or the internal CCN Gateway
i-Vu Port Configuration	Changing these values forces a web server restart. Default values: HTTP: 80 HTTPS: 443
Operation Status	Message showing progress of background operations, such as backup and restore.

Manage Server Data

- **PC Backup** - Saves the entire database zipped into one file to your computer.
- **PC Restore** - Replaces the current server data with a backup from your computer.
- **USB Backup** - Saves the entire database zipped into one file onto a USB inserted into the i-Vu® web server.
- **USB Restore** - Replaces the current server data with a backup from your USB inserted into the i-Vu® web server.
- **Compress System** - Creates more storage space for trend data.
- **Factory Defaults** - Deletes all server data and resets the device to the original factory default values.

NOTE Executing this option does not delete configuration data under the **Addressing** and **i-Vu Port Configuration** sections of the Management Tool.

Machine Maintenance

- **Management Version** - Apply .update file from here.
 - **Reboot** - System restart
-

Configuring NTP

Network Time Protocol (NTP) is a networking protocol for clock synchronization. You can designate an NTP source that sends the correct time to the i-Vu® web server, ensuring constant accurate time. You can enter 2 static addresses (DNS name or IP) of NTP servers or use the default addresses provided by the i-Vu® application. If you do not enable NTP, the i-Vu® system clock must be monitored and updated regularly in the **System Options** menu > **General** tab.

You can configure DHCP servers to supply IP addresses of NTP servers to the i-Vu® web server. If you have checked **Obtain an IP address automatically** and **Enable Time Synchronization**, the i-Vu® web server tries to obtain an NTP server address from the DHCP server on site. If it cannot find one, the i-Vu® web server uses the User Assigned NTP addresses, if any, in the User Assigned fields.



CAUTION Contact your Network Administrator for guidance in entering these settings.

You can access NTP from a local server, a remote server, or a website. To set up NTP:

- 1 Verify that **Enable time synchronization from an NTP server** is checked.
- 2 **System Assigned NTP Server Address** - To use this read-only field, make sure you have checked **Obtain an IP address automatically** to allow your system to search for an address for the NTP server and display a primary and alternate address.
- 3 **User Assigned NTP Server Address** - You can use the default website addresses if your system allows it. Firewalls may prevent successful access to the default websites. Your Network Administrator can provide alternate addresses for a local server, a remote server, or a website.

Set up login and passwords for an additional user

Add new operators and assign an appropriate role to them.

We recommend that you

- Assign the **Administrator** role for the main system user
- Create one additional user with the **Installer** role, using a common login name and password that can be used for i-Vu® jobs installed from your office. If the original Installer password is lost, someone can still access the i-Vu® system and reset the lost password.

NOTES

- Use the chart below or the Help to become familiar with the viewing and editing capabilities of each role.
- Be sure to record the user name and password for the first operator in the i-Vu® **Owner's Guide**.
- You cannot leave the password blank for Tenant Billing Applications. (Available for i-Vu® Plus only.)

Operators tab

Select the necessary settings and assign **Roles** (access rights) to set up operators.

NOTES

- Optimal number of simultaneous users:
 - 2 in the i-Vu® Standard application
 - 10 in the i-Vu® Plus application
- We highly recommended that only 1 user at a time commission the system.

To add or edit operators, passwords, and roles

- 1 Click **Main Menu** ▼, then select **System Options**.
- 2 Select **Operators** tab.
- 3 Click **Add** to enter a new operator, or, select an operator to edit his settings.
- 4 Enter information as needed. The required fields are **Name, Login Name, and Roles**. See table below.
- 5 Click **Accept** or **Apply**.

Field	Notes
Login Name	Must be unique within the system.
Force user to change password at login	Forces the operator to change his password immediately after his next login. NOTE You can combine the use of this field and the Change Password field to create a temporary password that the operator must change after his next login.
Starting Location	Set the starting location for each individual operator by choosing the specific area or controller in the navigation tree and the starting page from the drop-down menu.
Roles	See table below.

	Guest		Standard User		Power User		Admin		Installer	
	Accessible	Editable	Accessible	Editable	Accessible	Editable	Accessible	Editable	Accessible	Editable
Installer > Discovery - Find Routers and Devices, Arrange User View									✓	✓
Navigation menu - Change display name					✓	✓	✓	✓	✓	✓
System Options > My Settings tab (change password)			✓	✓	✓	✓	✓	✓	✓	✓
System Options > Operators, General, Security, Update, Add-ons tabs							✓	✓	✓	✓
System Options > Daylight Saving tab					✓	✓	✓	✓	✓	✓
Lock or Force a point	✓		✓		✓	✓	✓	✓	✓	✓
Change setpoints - Occupied/Unoccupied Heating/Cooling	✓		✓	✓	✓	✓	✓	✓	✓	✓
Change setpoints - Demand Limits, setpoint tuning parameters	✓		✓		✓		✓	✓	✓	✓
Global Modify	✓		✓		✓	✓	✓	✓	✓	✓
Global Copy									✓	✓
Properties > Equipment, I/O, Alarm Sources, Trend Sources, Network Points	✓		✓		✓	✓	✓	✓	✓	✓
Equipment Checkout, BACnet Points									✓	✓
Schedules > View, Reports	✓	✓	✓	✓	✓	✓	✓	✓	✓	✓
Configure			✓	✓	✓	✓	✓	✓	✓	✓
Schedule Groups			✓	✓	✓	✓	✓	✓	✓	✓
Alarms > View, Reports	✓		✓		✓	✓	✓	✓	✓	✓
Actions, Enable/Disable, Category					✓	✓	✓	✓	✓	✓
Trends > Enabled Points > View	✓		✓		✓	✓	✓	✓	✓	✓
New>View, Configure, Enable/Disable					✓	✓	✓	✓	✓	✓
Reports > Alarms, Schedules, Equipment	✓		✓		✓	✓	✓	✓	✓	✓
New							✓	✓	✓	✓
Security							✓	✓	✓	✓
Commissioning									✓	✓
Right-click menu in tree - Configure, Modstat, Copy Path							✓	✓	✓	✓
Right-click menu in tree - Driver Properties, Airflow Config, Reload Control Program, Copy Control Program Properties									✓	✓
Tenant Billing							✓	✓	✓	✓

Setting up i-Vu® client devices and web browsers

The i-Vu® system can be viewed on the following client devices and web browsers.

A computer¹ with this operating system...	Supports these web browsers...	
Windows®	Google™ Chrome™ v23.0 or later ² Internet Explorer® v8, v9, v10, or v11 Desktop Mozilla® Firefox® v21.0 or later	
Linux®	Google Chrome v23.0 or later Mozilla Firefox v21.0 or later	
Mac® OS X® (Apple® Mac only)	Safari® v6 or later ³ Google Chrome v23.0 or later Mozilla Firefox v21.0 or later	
A tablet with this operating system	Web browser	Tested tablets^{4, 5}
iOS	Safari v6 or later	Apple® iPad®
Windows® RT	Internet Explorer® 10/11 or Metro-style Internet Explorer® 10/11	Microsoft® Surface
Windows® 8 or 8.1 Pro	Internet Explorer® 10/11 or Metro-style Internet Explorer® 10/11	Microsoft® Surface™ Pro
Android™	Google™ Chrome™ v23.0 or later	Google™ Nexus™ 7 and 10

1 The client computer should have at least:

- Dual core processor
- 1.5 GB RAM
- Communications link of 10 Mbps or higher

The i-Vu® application will work with slower computers and slower links, but the results may not be satisfactory.

2 Best performance

3 Best performance unless browser is running on a Mac® Mini or a MacBook:

-  **WARNING** If machine is running Mountain Lion 10.8x with an integrated Intel HD 400 graphics card, it will experience display issues, Use one of these workarounds for better performance:
- If an additional NVIDIA graphics card is available, manually switch the graphic card setting in MAC® OS X® to use that card.
 - If not, use Google™ Chrome™ v23.0 or later.

4 Most of the tablets listed do not support plug-ins (Java Runtime Environment, Flash, PDF reader, etc.) so some i-Vu® add-on applications and other features may not work. The Surface Pro with IE 10 Desktop does support plug-ins.

5 Touch functionality on tablets not tested by Carrier may or may not work with i-Vu®. Use at your own risk.

Setting up and using a computer with the i-Vu® system

- Set the monitor's screen resolution to a minimum of 1024 x 768 with 24- or 32-bit color quality
- You may want to disable the computer's navigation sounds.

Mac only

NOTE The instructions below are for a Mac OS X 10.8. Other versions may vary slightly. See your computer's Help if necessary.

Computer settings	To change setting...
Enable right-clicking to see right-click menus:	
On a Mac	<ol style="list-style-type: none"> 1 Select System Preferences > Mouse. 2 Click the drop-down list that points to the mouse's right-click button, then select Secondary Button.
On a MacBook	<ol style="list-style-type: none"> 1 Select System Preferences > Trackpad. 2 Enable Secondary click.

The instructions in Help are for a Windows computer. For instructions that include the **Ctrl** key, replace **Ctrl** with **Command**. For example, replace **Ctrl+click** with **Command+click**.

Linux only

The instructions in Help are for a Windows computer. **Alt+click** on a Windows computer is accomplished by **Ctrl+Alt+click** on a Linux computer.

Using a tablet with the i-Vu® system

You can view your i-Vu® system on tablets that have the following operating systems and web browsers, but some functionality may be changed or limited. Issues with each tablet are discussed below.

Tablet operating system	Web browser	Tested tablet*
iOS	Safari® v6 or later	Apple® iPad®
Windows® RT	Internet Explorer® 10 or Metro-style Internet Explorer® 10	Microsoft® Surface

Tablet operating system	Web browser	Tested tablet*
Windows® 8 or 8.1 Pro	Internet Explorer® 10/11 or Metro-style Internet Explorer® 10/11	Microsoft® Surface™ Pro
Android™	Google™ Chrome™ v23.0 or later	Google™ Nexus™ 7 and 10

* Touch functionality of tablets not tested by Carrier may or may not work with i-Vu®. Use at your own risk.

All tablets

- To access the right-click menu for:
 - The action pane–Touch and hold the item for several seconds.
 - A tree item–Select the item first, then touch and hold the item for several seconds.
- Audible alarms do not generate a sound.
- Firefox currently has many problems supporting touch gestures on tablets.
- To clear the browser's cache, see *Setting up and using a web browser to view the i-Vu® interface* (page 22).

iPad

- Double-tap to zoom in/out.
- The **Jump To** feature does not work in Safari® on an iPad® due to way Safari handles JavaScript on secondary tabs.
- A i-Vu® feature that opens a pop-up window on a computer (for example, Global Modify) will open in a new tab in Safari.

NOTE Some of these features will present the message **This site is attempting to open a pop-up window.** Select **Allow** to continue.

- iOS restricts access to a file system so i-Vu® features that upload or download files on a computer client are disabled on an iPad. This applies to the following configuration features:
 - Configure > Edit Existing or Add New** (views, control programs, screen files, drivers)
 - Import clipping**
 - System Options > General > Source Files > Export or Import**
 - System Options > General > Logs > Download**
 - System Options > Security > Permissions > Add**
 - System Options > Daylight Saving > Import**
 - System Options > Add-ons > Install Add-on**
 - System Options > Update** (patches, service packs, drivers, language packs, graphics libraries, help)
 - Reports saved as XLS
- iOS does not support plug-ins (Java Runtime Environment, Flash, etc.) so some i-Vu® add-on applications will not work on an iPad.

Microsoft Surface and Surface Pro

- Pinch-zoom works on individual frames, instead of the whole screen. This means you can zoom and scroll the navigation pane and action pane separately.
- The Surface RT and IE 10 or 11 Metro do not support plug-ins (Java Runtime Environment, Flash, PDF reader, etc.) so the following features will not work.
 - Some i-Vu® add-on applications
 - The **Reports** page **PDF** button

You can use the Surface Pro with IE 10 or 11 Desktop if you need these features.
- If browser text is too small, use **Ctrl +** to increase Internet Explorer's zoom level, then reload the page.

Google Nexus

- The Nexus does not support plug-ins (Java Runtime Environment, Flash, PDF reader, etc.) so the following features will not work.
 - Some i-Vu® add-on applications
 - The **Reports** page **PDF** button

Setting up and using a web browser to view the i-Vu® interface

To set up and use Internet Explorer

NOTES

- The instructions below are for Internet Explorer 9. Other versions may vary slightly. See your web browser's Help if necessary.
- If the menu bar is not visible, right-click on the window's header, and then select **Menu bar**.

Web browser settings	To set in Internet Explorer...
Accept First-party and Third-party cookies	Tools > Internet Options > Privacy > Advanced button
Automatically check for newer versions of stored pages	Tools > Internet Options > General > Browsing history > Settings button
Load ActiveX Control	Tools > Internet Options > Security > Custom Level button. Under ActiveX controls and plug-ins , set the following: <ul style="list-style-type: none"> • Download signed ActiveX controls > Prompt • Download unsigned ActiveX controls > Disable • Run ActiveX controls and plug-ins > Enable • Script ActiveX controls marked safe for scripting > Enable
Select Play animations in web pages	Tools > Internet Options > Advanced > under Multimedia

Web browser settings	To set in Internet Explorer...
Do not save passwords if the computer is used by multiple operators	Tools > Internet Options > Content > AutoComplete > Settings button
Disable all the options on the Explorer Bar	View > Explorer Bars
Disable web browser's pop-up blockers	Tools > Pop-up Blocker > Turn Off Pop-Up Blocker
Disable external toolbar pop-up blockers	Varies
Hide the web browser's toolbars	View > Toolbars
To...	Do the following...
Maximize the web browser window	Press F11 on your keyboard to turn full-screen mode on/off, or use the minimize/maximize button in the top right corner of the browser window.
Have 2 different users logged in to the i-Vu® system on the same computer	Start a new web browser session. Select File > New Session .
Clear browser cache	<ol style="list-style-type: none"> 1 Select Tools > Internet Options. 2 Click Delete. 3 If you had the i-Vu® system saved as a Favorite, uncheck Preserve Favorites website data. 4 Click Delete again.

To set up and use Mozilla Firefox

NOTES

- The instructions below are for Mozilla® Firefox® v21.0 on a Windows operating system. Other versions may vary slightly. See your web browser's Help if necessary.
- For the first two items in the table below, Linux instructions are in parentheses. All other instructions are the same for Windows and Linux.
- If the menu bar is not visible, click  in the top left corner, and then select **Options > Menu bar**.

- If a message appears in the i-Vu® interface that includes the checkbox **Prevent this page from creating additional dialogs**, DO NOT check this box.



Web browser settings	To set in Firefox...
Disable Pop-up blocker	Tools > Options > Content > uncheck Block pop-up windows (In Linux: Edit > Preferences > Content)
Enable JavaScript	<ol style="list-style-type: none"> 1 Select Tools > Options > Content > Enable JavaScript. (In Linux: Select Edit > Preferences > Content) 2 Click the Advanced button to the right of Enable JavaScript, then verify the following options are checked: <ul style="list-style-type: none"> • Move or resize popup windows • Raise or lower windows • Disable or replace context menus
Add-ons Manager	Select Tools > Add-ons . On this page, you can enable/disable installed add-ons such as: <ul style="list-style-type: none"> • Adobe® Acrobat® Reader (to view PDF's) • QuickTime Plug-in (to play audible alarms) Only installed Firefox add-ons will show up in the list.
To...	Do the following...
Maximize the web browser window	Press F11 on your keyboard to turn full-screen mode on/off.
Clear browser cache	Select Tools > Options > Advanced > Network > Cached Web Content > Clear Now .
Have 2 different users logged in to the i-Vu® system on the same computer	Start a new web browser session. Select File > New Private Window .

To set up and use Google Chrome

NOTES

- The instructions below are for Google™ Chrome™ v23.0. Other versions may vary slightly. See your web browser's Help if necessary.
- If a message appears in the i-Vu® interface that includes the checkbox **Prevent this page from creating additional dialogs**, DO NOT check this box.

On a computer

Web browser settings	To set in Chrome...
Enable pop-ups	<ol style="list-style-type: none"> 1 Click  on the browser toolbar. 2 Select Settings. 3 Click Show advanced settings. 4 Under Privacy, click Content settings. 5 Under Pop-ups, do one of the following: <ul style="list-style-type: none"> • Select Allow all sites to show pop-ups. • Click Manage exceptions. Type your system's IP address or server name in the Hostname pattern field, then set Behavior to Allow.
To...	Do the following...
Clear browser cache	<ol style="list-style-type: none"> 1 Click  on the browser toolbar. 2 Select Tools > Clear browsing data. 3 Check the types of information that you want to remove. 4 Select a time range in the drop-down list. 5 Click Clear browsing data.
Maximize the web browser window	Press F11 on your keyboard to turn full-screen mode on/off.
Have 2 different users logged in to the i-Vu® system on the same computer	Start a new web browser session. Click  , then select New Incognito window .

On a Google Nexus

Web browser settings	In the Chrome menu...
Turn off desktop mode	Uncheck Request desktop site .
Disable pop-up blocker	Settings > Advanced > Content Settings > uncheck Block pop-ups
Enable JavaScript	Settings > Advanced > Content Settings > check Enable JavaScript
Enable Cookies	Settings > Advanced > Content Settings > check Accept Cookies
To...	In the Chrome menu...
Clear browser cache	Settings > Advanced > Privacy > CLEAR BROWSING DATA

To set up and use Safari

NOTES

- The instructions below are for Safari® v6. Other versions may vary slightly. See your web browser's Help if necessary.
- We recommend that you do not run Safari in full-screen mode. If you do, i-Vu® pop-ups will open full-screen, covering the main application window.

On an Apple® computer (Mac®)

Web browser settings	To set in Safari...
Disable pop-up blocker	Preferences > Security > uncheck Block pop-up windows.
Enable JavaScript	Preferences > Security > check Enable JavaScript.
Enable Plug-ins	Preferences > Security > check Enable plug-ins.
Prevent pop-ups from opening in a new browser tab	Preferences > Tabs > uncheck Command-click opens a link in a new tab.
Prevent Safari from automatically opening zip files exported from the i-Vu® application	Preferences > General > uncheck Open "safe" files after downloading.
To...	Do the following...
Clear browser cache	History > Clear History.
Have 2 different users logged in to the i-Vu® system on the same computer	Start a new web browser session. Select Safari > Private Browsing. Then select File > New window.

On an Apple® iPad

Web browser settings	To set on the iPad...
Disable pop-up blocker	<ol style="list-style-type: none"> 1 In the Settings app, select Safari. 2 Set Block pop-ups to Off.
Enable JavaScript	<ol style="list-style-type: none"> 1 In the Settings app, select Safari. 2 Set JavaScript to On.
To...	Do the following...
Clear browser cache	In the Settings app, select Safari > Clear History.

Troubleshooting



CAUTION! Do NOT open the i-Vu® web server! Opening the web server voids your warranty.

If using DHCP and can't access the i-Vu® web server with Internet Explorer, by computer name

Notes about the i-Vu® application and DHCP addressing



The i-Vu® web server is configured to automatically obtain an IP address using DHCP. When the i-Vu® application is turned on, it sends a request out its LAN cable to a DHCP server and asks the server to supply it with its IP configuration.

This IP configuration consists of:

- IP address
- Subnet mask
- Default gateway
- DNS address

If a DHCP server is not available, as in the case of connecting the i-Vu® web server directly to a computer, the i-Vu® web server assigns an internal IP address to its Network Interface Card. The computer that is directly connected to the i-Vu® web server also assigns itself an IP address if it is set up for DHCP. The network portion of each of these IP addresses are identical, 169.254.xxx.xxx. The remaining two octets of each IP address are different. This ensures that communication is possible on the IP network consisting of the i-Vu® web server and the computer.

i-Vu® web server connected to computer with a crossover cable

- 1 Verify that the i-Vu® web server is on.
- 2 Check that a valid Ethernet connection exists. (See *Example 1* (page 29).)
- 3 Click **Start** and type "cmd" in the Search box,  and click Enter. Type "ping ivu" to ping the i-Vu® application's default name. (See example 3). If you see 4 successful replies, then check Internet Explorer to determine if a proxy server or automatic configuration script is being used and disable them. (See *Example 2* (page 30).)
- 4 Try accessing the i-Vu® web server again.
- 5 If after performing step 3, the i-Vu® web server still isn't accessible from Internet Explorer, or the Ping command in step 3 failed,
 1. Click **Start** and type "cmd" in the Search box,  and click Enter.
 2. Type the following commands: "nbtstat -R" and click Enter.
 3. Type in "ipconfig /flushdns" and click Enter.
- 6 If the i-Vu® web server is still inaccessible from Internet Explorer, try pinging the web server again.

Troubleshooting

- 7 If the i-Vu® web server still does not respond to the PING command, try pinging the name of the computer connected to the i-Vu® web server. If this is successful, reboot the i-Vu® web server, and try pinging it.
- 8 If it still fails the PING test, connect a monitor to the i-Vu® web server and reboot.

At the end of the boot process, the i-Vu® web server displays its IP configuration. If the **i-Vu Address** is something other than 169.254.xxx.xxx, the i-Vu® application is not set to use DHCP and is assigned a static IP address. In this case, to access the i-Vu® application, it is necessary to configure the IP settings of the computer's Network Interface Card (NIC) to be on the same network as the i-Vu® web server. After reconfiguring the NIC, access the i-Vu® application with browser, using the server IP address shown on the monitor.

NOTE If pinging the computer name fails, the network connection on the computer is either disabled, disconnected, or in need of repair. Call Carrier Control Systems Support for assistance.

i-Vu® device plugged into LAN

- 1 Verify that the i-Vu® web server is on.
- 2 Check that a valid Ethernet connection exists. (See Example 1.)
- 3 Open a Command window (See Example 3.) and ping the i-Vu® web server by its default name (ivu).
 - If pinging is successful, then the problem is most likely in the computer's browser settings. Check Internet Explorer to determine if a proxy server or automatic configuration script is being used (See *Example 2* (page 30)).
 - If you are using a proxy server, you must add the name of the i-Vu® web server to the exceptions list of the proxy server. (See Example 4)
 - If an auto-configuration script is being used, adding the i-Vu® web server to the exceptions list is not possible. Contact your local Information Technology (IT) group for assistance.
 - If pinging fails, but i-Vu®'s name is resolved to an IP address, as shown below, the problem could be that pinging is disabled on the LAN.

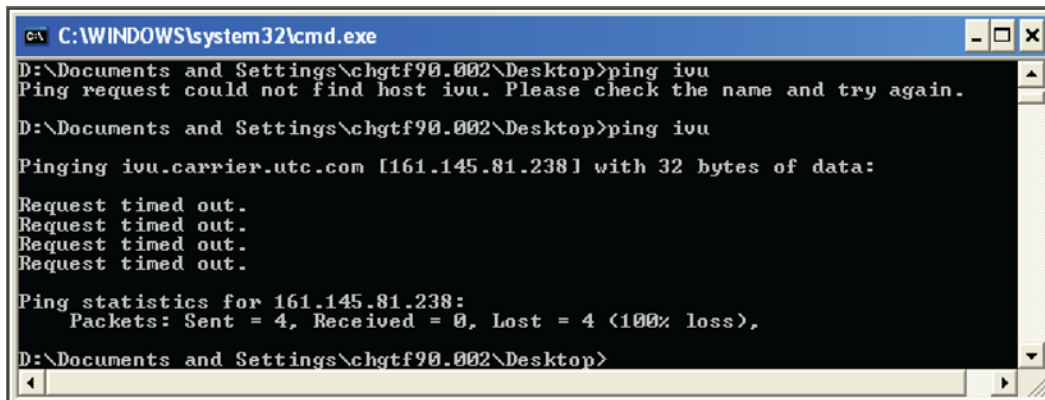

```
C:\WINDOWS\system32\cmd.exe
D:\Documents and Settings\chgtf90.002\Desktop>ping ivu
Ping request could not find host ivu. Please check the name and try again.

D:\Documents and Settings\chgtf90.002\Desktop>ping ivu

Pinging ivu.carrier.utc.com [161.145.81.238] with 32 bytes of data:

Request timed out.
Request timed out.
Request timed out.
Request timed out.

Ping statistics for 161.145.81.238:
    Packets: Sent = 4, Received = 0, Lost = 4 (100% loss),

D:\Documents and Settings\chgtf90.002\Desktop>
```

- If this is the case, check the proxy server settings in Internet Explorer as in *Example 2* (page 30).
- If the problem isn't with the proxy server settings and pinging is enabled on the LAN, failing to ping successfully could mean that i-Vu®'s name is resolving to an incorrect IP address.

Try the following:

- 1 Open a Command window (See Example 3) and type in the following commands: “nbtstat -R” <enter>.
- 2 Type in “ipconfig /flushdns” <enter>.
- 3 Try pinging the i-Vu® web server again by name.
 - If successful, try accessing the i-Vu® application with Internet Explorer. If not successful try accessing it in Internet Explorer by IP address, i.e. http://161.145.81.238. If this is not successful, contact your local IT group to resolve this issue.
 - If pinging fails with any other error than what is shown in the graphic above, contact your local IT group to assist you. The IT group may want to know what IP address the i-Vu® web server is actually using. To determine this, connect a monitor to the i-Vu® DVI port in the back of the i-Vu® web server and power down. Now power up the i-Vu® web server and the IP configuration information displays at the end of the boot process.

Example 1: Determining if a valid Ethernet connection exists

Ensure there is a proper Ethernet connection, using one of the following methods:

- Click **Start** and type **ncpa.cpl** in the Search  box.
- Click **Start > Control Panel > Network and Internet > Network and Sharing Center > Change Adapter Settings**.

NOTE On the Control Panel screen, verify that **Adjust your computer's settings** is set to **View by: Small (or Large) Icons**.

Under LAN or high speed Internet, find your Network Interface Card icon and ensure that a red **X** is not displayed over the icon.

Note that in the following figure:

- The **Local Area Connection** is enabled and connected
- The **Wireless Connection** is enabled, but not connected
- The 2 other connections are disabled

If the connection that is used for the i-Vu® web server shows a red **X**, then check that the Ethernet cable is fully plugged in and that the correct type of Ethernet cable is being used, i.e. crossover or patch cable.

You must have a live Ethernet connection to successfully connect to the i-Vu® web server.

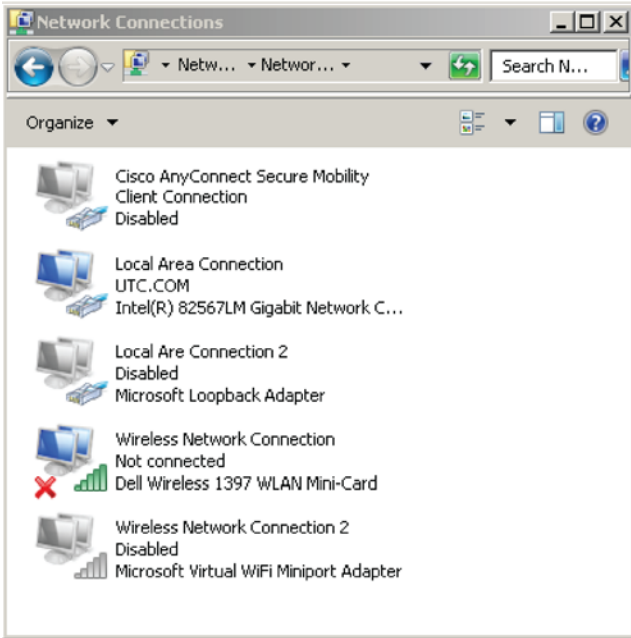

Example 2: Determining if Internet Explorer is using a proxy server

- 1 Launch Internet Explorer and go to **Tools** or click  > **Internet Options** > **Connections** and click the **LAN Settings** button.
- 2 Uncheck every checkbox in this dialog window to disable proxy server usage, as shown below.

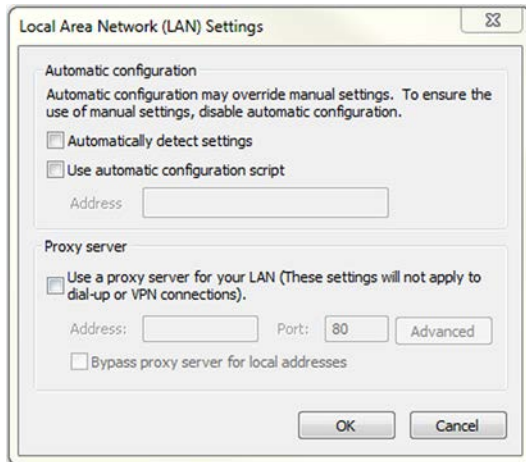

- 3 Click **OK**.
- 4 Click **OK** again.
- 5 Close all instances of Internet Explorer.
- 6 Launch Internet Explorer again and access the i-Vu® application.

Example 3: Pinging by computer name

- 1 Click **Start** and type “cmd” in the Search box and click **Enter**.
- 2 Type “ping ivu” to ping the default name of the i-Vu® web server. If you have a good connection, you should see 4 replies.

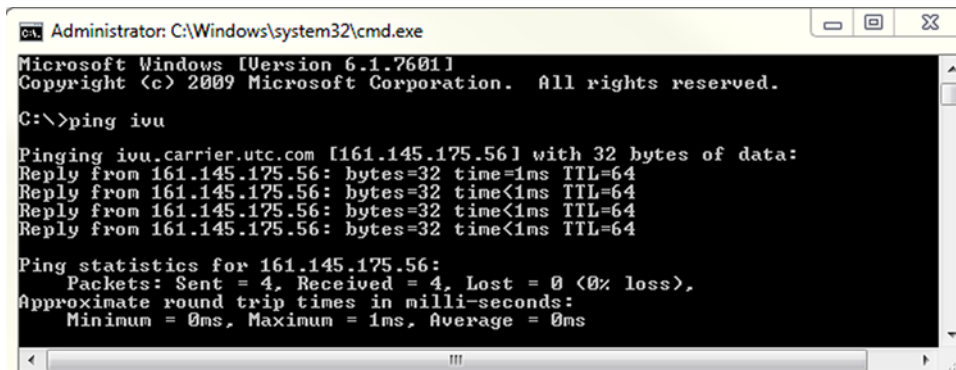

- 3 Note name and IP address.

Example 4: Adding exceptions to a proxy server in Internet Explorer

- 1 Launch Internet Explorer and go to **Tools** or click > **Internet Options** > **Connections** and click the **LAN Settings** button.
- 2 Verify that the **Proxy Server** checkbox is checked.



Troubleshooting

- 3 Click the **Advanced** button and enter the address and port, and the name of the i-Vu® web server followed by an asterisk in the **Exceptions** list.

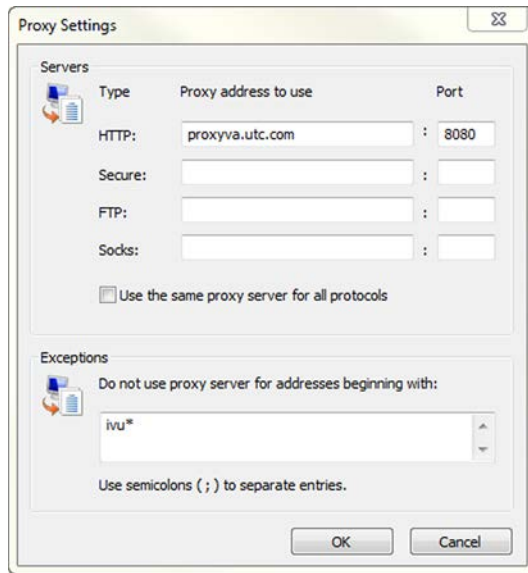

- 4 Click **OK** to close each dialog window.
- 5 Close Internet Explorer and re-open it for the new settings to take effect.

DVI to VGA converter

The DVI to VGA converter allows you to plug a monitor directly into the i-Vu® web server in the event that you have lost your system name and system IP address.

System Management

Although the i-Vu® application is a reliable front-end, you must perform periodic backups of the i-Vu® database to ensure a quick recovery in case of failure. To make sure that your controllers have the latest version of software you must install periodic library upgrades. The sections below describe how to backup and restore the i-Vu® database and how to install the library updates.

Backup data from Management Tool

Access the **Management Tool** using one of the following methods:

- Click **Main Menu** ▼ in the i-Vu® interface, then select **System Options > General tab > Management Tool**.
- Launch your browser and type your system name followed by :8080. For ex.: <http://ivu:8080/>.

Use either of the following methods to backup your data:

Backup data to your computer

- 1 Click **PC Backup** under **Manage Server Data** to save the entire database zipped into one file to your computer.
- 2 Click **OK** when you see the message **The system will be stopped and restarted. Do you wish to proceed?** Watch **Operation Status** to see the progress.
- 3 Click the message **Save/Download Backup File to Your Local Hard drive** when it appears.
- 4 Click **Save** when asked **Do you want to open or save this file?**
- 5 Save this system.backup.tgz file to a convenient location on your computer.

CAUTION! Do not alter the name of this file!

- 6 Exit from **Management Tool**.

Backup data to a USB drive

- 1 Plug your USB drive into any available USB port on your i-Vu® web server.
NOTE Do not use the i-Vu® **Restore** USB drive!
- 2 You must reboot in order for the web server to find the USB drive. Click **Reboot** under **Machine Maintenance** in the **Management Tool**.
- 3 Click **OK**.
- 4 When reboot is complete, click **USB Backup** under **Manage Server Data**.
- 5 Click **OK** when you see the message **The system will be stopped and restarted. Do you wish to proceed?**
- 6 When **Operation Status** says **No Background Operations Currently Active**, remove USB drive from the i-Vu web server.
- 7 Exit from **Management Tool**.

Restore data from backup

- 1 Click **PC Restore** or **USB Restore** under **Manage Server Data** in the **Management Tool**.
 - o **PC Restore** - Browse to your backup file and click **Perform Restore**.
 - o **USB Restore** - Place your backup USB drive in any port on the i-Vu® web server. Select the backup file and click **Perform Restore**.
- 2 Restore is complete when **Operation Status** displays **No Background Operations Currently Active**.
- 3 If you wish to change the name of your i-Vu® system from the default **Ivu**, enter the new name in the **Name** field under **Addressing**. The restore process does not automatically reinstate your previous name.

Restore factory defaults

Restoring factory defaults deletes your existing data and restores your system to factory defaults. This restore process is quicker than using the **Restore** CD or **Restore** USB drive.

- 1 Access the **Management Tool** by clicking , then selecting **System Options > General tab > Management Tool** or via your browser by typing your system name followed by :8080.
For ex.: http://ivu:8080.
- 2 Click **Factory Defaults**. This deletes all server data and resets the device to the original factory default values.
- 3 **NOTE** Executing this option will not delete configuration data under the **Addressing** and **I-Vu Port Configuration** sections of the Management Tool.
- 4 Begin setting up your system.

Restore i-Vu® system

From i-Vu® Restore CD:



CAUTION! Placing the **Restore** CD in the i-Vu® disk drive reformats your system and restores it to factory defaults. Library updates are lost and you must reapply them.

- 1 Remove the i-Vu® web server from the network by disconnecting the LAN cable.
- 2 Insert the i-Vu® v6.0 **Restore CD** into the i-Vu® web server CD drive.
- 3 Shut down the i-Vu® web server by pushing the On/Off button **once**. Wait for the blue light to turn off (could take as long as 2 minutes).
- 4 Press the On/Off button again to restart the web server. The installation begins automatically.
- 5 The **Restore CD** ejects when the installation is complete. This process takes several minutes.
NOTE Do not power off during the installation.
- 6 Wait another minute or two before accessing the new system using Internet Explorer.

From i-Vu® Restore USB drive:



CAUTION! Placing the **Restore** USB drive in the i-Vu® web server USB port reformats your system and restores it to factory defaults. Library updates are lost and you must reapply them.

- 1 Insert the **Restore** USB drive into any i-Vu® web server USB port.
- 2 Shut down the web server by holding down the **On/Off** button for several seconds. Then wait for the blue lights to go out before restarting.
- 3 Press the **On/Off** button again to restart. The restore process starts automatically and takes several minutes. The web server shuts off when finished.

NOTE Do not turn the power off during reformatting!

- 4 Wait another minute or two before accessing the new system using a browser.

Update the equipment library

The i-Vu® SAL files update your i-Vu® controllers. The SAL libraries contain control programs, graphics, drivers, screen files, and other important controller data.

Carrier periodically provides updates, which include enhancements and bug fixes.

NOTES

- The library update only changes **default** graphics. If you have edited your graphic in ViewBuilder, it is not updated.
- The last digits in the SAL library name are the release date of the library.
- All of the SAL files will not necessarily have the same <date> revision.
- To ensure that your installation is running the latest software, we recommend that you check *Control Systems Support* <http://www.hvacpartners.com/> for updates. Download the latest SAL files and apply them to all new installations.
- If you are changing to an older SAL file than the current one being used, a warning asks you if you are sure you want to apply an older version.

There are currently 6 SAL files used by the i-Vu® v6.0 application:

- ivu-6.0-factory-<date>.sal (for PIC-based controllers)
- ivu-6.0-upc-open-<date>.sal (for Universal Protocol Converter-based equipment)
- ahub-6.0-<date>.sal (for 39m AHU applications)
- ivu-6.0-universal-controller-<date>.sal (for UC Open and AppController-based applications)
- ivu-6.0-applicationbuilder-<date>.sal (for CCN applications)
- ivu-6.0-discovery-<date>.sal (for CCN PIC applications)

NOTE Keep copies of the latest libraries in a safe place. In the event of a system restore, the updated .sal file must be reapplied.

To check current SAL library version

- 1 Login to the i-Vu® application using the **Installer** role.
- 2 Click **Main Menu** ▼, then select **System Options > Update** tab.
- 3 Click **Current Libraries (.sal)** to view the current SAL libraries and their revision date.

Step 1: Update library

- 1 Save the updated library (.sal file) to your computer.
- 2 Click **Main Menu** ▼, then select **System Options > Update** tab.
NOTE Expand **Current Libraries (.sal)** to see the current SAL libraries and their revision. Compare them to what you downloaded from the *Carrier support website* <http://www.hvacpartners.com> to determine if any of them have been updated.
- 3 Click **Update Library** and browse to the updated .sal file that you have saved on your computer, select the file, and click **Open**.
- 4 Click **Continue**.
- 5 When process is complete, the message appears **File added successfully**.
- 6 Click **Close**.

NOTE These changes are not applied to the controllers until you have updated routers and controllers.

Follow these steps to implement the new equipment library:

Step 2: Update the files for the routers

- 1 Select the router that you wish to update in the navigation tree.
- 2 Right-click and select **Driver Properties**.
- 3 Select **Properties** page > **Update** tab.
- 4 If the database contains 2 or more routers, you must check **Change for all control programs of this type** in the **Controller** section.
- 5 Click **Update**. A message appears **Changes the driver and screen file to use the current library version. Continue?**
NOTE If more than one router exists, the additional routers are listed below the **Update** button.
- 6 Click **OK**.
- 7 Click **Accept**.

Step 3: Update the files for the controllers

- 1 Double-click the controller in the navigation tree or right-click and select **Configure** .
- 2 If you have multiple controllers of the same type, enable **Change for all control programs of this type?**
- 3 Click **Update** under **Controller**. A message appears **Changes the control program, view, driver and screen files to use the current library version. Continue?**
- 4 Click **OK**. When the message **Updated to the library version xx.** appears, click **Close**.
- 5 Repeat steps 1 - 4 for any additional types of controllers.
- 6 Click **Close** again.

Step 4: Update the files for CCN controllers

- 1 In the navigation tree, select the CCN device manager associated with the controllers that are to be updated.
- 2 Select the **Devices** tab and re-scan any controllers that need to be updated by checking **Rescan Controllers Selected Below for Configuration Changes** and clicking **Start Scan**.

Step 5: Apply the update to the routers and controllers

- 1 Select the site level in the navigation tree and then select the **Downloads** page.
- 2 If you wish to apply the new SAL file to your entire system, you can use this page to compare to your navigation tree and verify that you have selected all of your routers and controllers for download.
NOTE Only the CCN Gateway and device managers require download, so the CCN controllers/equipment will not be listed.
- 3 A network's controllers download in the order shown. To change the order, select a controller(s), then drag and drop or click **Move to Top** or **Move to Bottom**.
EXCEPTION If a controller's router requires a download, it will download first regardless of its position on the Download page. Click the **Start** button.

NOTES

- Use **Ctrl+click**, **Shift+click**, or the **Select All** checkbox to select multiple controllers.
 - Up to 5 routers can download simultaneously.
- 4 See To download from the Downloads page in Help for more details.

Synchronize to system time

To update all routers and controllers to the system time:

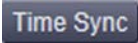
- 1 Click **Main Menu**  > **System Options** > **General** tab.
- 2 Click  to immediately synchronize all controllers.
- 3 To adjust the time when controllers are automatically synchronized each day, click **Enable time synchronization of controllers daily at** and fill in time.

Advanced topics

i-Vu® connection options and requirements

You can use any of the following common network configurations (see below for details):

- **Option 1** - Connect directly from a computer to the i-Vu® web server
- **Option 2** - Connect to the Intranet for internal network access only
- **Option 3** - Connect to the Internet through the Intranet for both internal and external access
- **Option 4** - Connect to the Internet through a dedicated broadband account

Option 1 - Connect directly from a computer to the i-Vu® web server

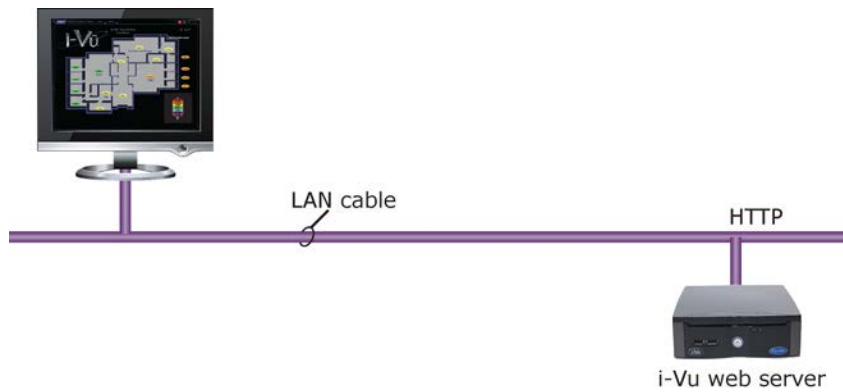

Requirements:

- Windows-based computer with supported web browser and available Ethernet port
- LAN Cable (either straight or crossover)

Email Options - None

Option 2 - Connect to a LAN for internal network access only

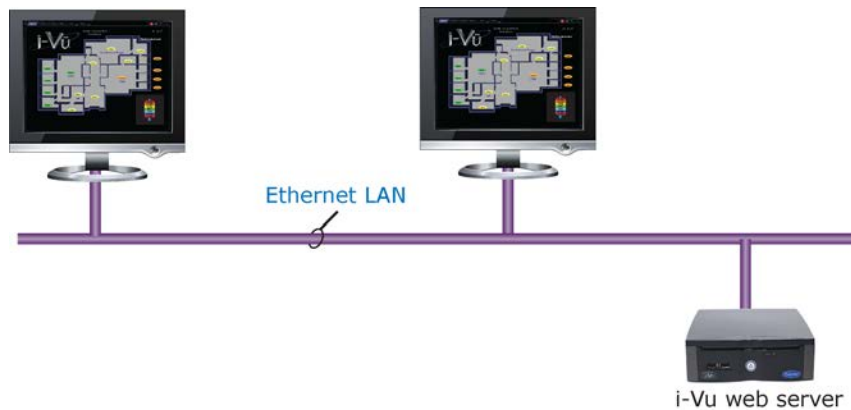

Requirements:

- Windows-based computer with supported web browser and Ethernet port
- Access to Ethernet LAN
- For i-Vu® Standard and Plus systems, you need a (DHCP or static) IP address for each of the following:
 - One IP address for the i-Vu® web server (required)
 - One IP address for the i-Vu® web server's internal router (optional)
 - One IP address for each external i-Vu® router (if applicable)

Email Options - Email can be sent from a local or an Internet mail server if network policies allow this.

Option 3 - Connect to the Internet through an Intranet for both internal and external access

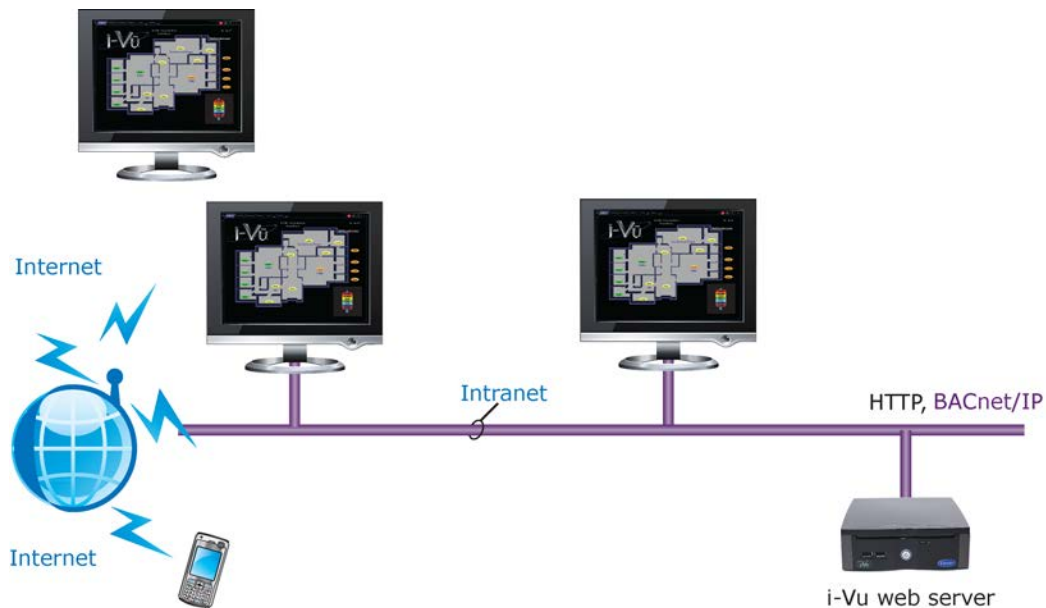

Requirements:

- Windows-based computer with supported web browser and Ethernet port
- Access to Ethernet LAN
- For i-Vu® Standard and Plus systems, you need a (DHCP or static) IP address for each of the following:
 - One IP address for the i-Vu® web server (required)
 - One IP address for the i-Vu® web server's internal router (optional)
 - One IP address for each external i-Vu® router (if applicable)
- Internet IP address provided by the site's IT personnel
- Open firewall port for HTTP/HTTPS traffic to the i-Vu® web server's IP address (default is port 80/443 respectively)

Email Options - Email can be sent from both Internet and Intranet mail servers. To send email off of the LAN, the DNS and domain field must be properly configured in the i-Vu® web server.

Option 4 - Connect to the Internet through a dedicated broadband account



- Window-based computer with supported web browser and Ethernet port
- Broadband Internet connection (internet IP address provided by the Internet Service Provider)
- IP router (w/Integrated Switch if computer or external i-Vu® routers will be used)
- For i-Vu® Standard and Plus systems, you need a (DHCP or static) IP address for each of the following:
 - One IP address for the i-Vu® web server (required)
 - One IP address for the i-Vu® web server's internal router (optional)
 - One IP address for each external i-Vu® router (if applicable)
- Open firewall port for HTTP/HTTPS traffic to the i-Vu® web server's IP address (default is port 80/443 respectively)

Email Options - Email can be sent from a local or an Internet mail server if network policies allow this.

Using a loopback address

You can successfully use a loopback address for the **USB Network Address** if you are using:

- USB Adapter (CCN or Open)

OR

- External routers with no USB Adapter connected



CAUTION! Do NOT use a loopback address if you are using both a USB Adapter and external routers and you intend the USB Adapter to communicate with other external devices on the IP network.

Finding devices is affected by plugging or unplugging the USB Adapter when using a loopback address for the USB network. If the USB adapter uses a loopback address, external discovery works as expected and finding devices under the USB Adapter works as expected. However, the USB Adapter and external IP devices will not be able to support features that require them to communicate with each other over IP

You can plug and unplug a CCN or Open USB Adapter into the web server without having to restart the system. However, you must refresh the system tree on the User view to update devices that are connected to the plugged or unplugged adapter.

If DHCP will not assign two IP addresses

The default IP configuration uses DHCP. the i-Vu® web server attempts to obtain its IP configuration information from a DHCP Server located on the same subnet. Most DHCP Servers will provide all of the information contained in the **Addressing** section of the **Management Tool**, as shown below.

However, there are some DHCP Servers that will not assign 2 IP addresses to 1 network card, or more specifically, to 1 MAC address.

As shown below, the i-Vu® web server is set for DHCP and all IP information looks valid except that the **USB Network Address** is configured for 127.0.0.1. This is called a loopback address and this IP address is not visible or accessible from the LAN. The warning in red indicates that you must assign a non-loopback address to the **USB Network Address**.

If using a loopback address, refer to *Using a loopback address* (page 41) for important details.

Addressing

Name:

Obtain an IP address automatically

i-Vu Address: . . .

Subnet Mask: . . .

Default Gateway: . . .

DNS Address: . . .

Domain:

USB Network Type:

USB Network Address: . . .

Warning: You must manually configure the IP address for the USB Network to a non-loopback address if that device is to communicate with other devices over an IP network.

In cases where the DHCP Server will not assign 2 IP addresses and the i-Vu® system uses both a USB Adapter and external routers, DHCP will not work. You must configure the i-Vu® system with static IP addresses. See Configure the i-Vu® system using a static IP address.

Finding the MAC address of the i-Vu® web server

In some cases, the IT personnel may ask for the Ethernet MAC address of the i-Vu® web server. There are two ways you can obtain this information.

Option 1

- 1 Login to the i-Vu® application using the Admin or Installer role.
- 2 Click **Main Menu** and select **Manual Command**.
- 3 Type **commstat** and click **OK**.
- 4 The Ethernet MAC address of the web server is listed as shown below.

```

Connection Type          Status      User Count  Lock Cnt/Time
=====
BACnet/IP Connection    Connected  1           0/ 0

User Name                Activity Time
=====
System                   1188

**** BACnet Settings ****
client service: local:172.16.1.37 subnet=172.16.255.255 port=47808 objid=8:169999 network=1600
Event Recipient: 169999
local:172.16.1.37 subnet=172.16.255.255 port=47808 objid=8:169999 network=1600 MAC Address=00-01-80-66-2d-65 DisableFieldEvents=false
Tuning parameters:
BACnet/IP Connection Comm Retries=3
BACnet/IP Connection Comm Timeout (in millis)=4000
BACnet/IP Connection Do Sync (in millis)=3600000
BACnet/IP Connection Register FD Interval (in sec)=600
    
```

Option 2

- 1 Connect a monitor to the i-Vu® web server. Once the server has started up, it displays the **System Information**.
- 2 The Ethernet MAC address is displayed in the fourth line.

Using TCP/UDP ports

Server Ports	
Port	Protocol/User
tcp*:80	http (Web Server)
tcp *:443	https (Web Server)
tcp *:8080	http (Management Tool)
udp *:68	DHCP Client daemon
udp *:137	nmbd (netbios/tcp requests)
udp *:138	nmbd (netbios/tcp responses)
udp *:47808	Bacnet/IP
udp *:47812	CCN/IP
Udp *:50005 to 50008	Firmware CCN/IP
udp *:47806	Alarm Notification Client

NOTES

- The i-Vu® web server listens through the ports.
- SOAP uses the HTTP port.
- HTTP and HTTPS ports are user-viewable and definable on **System Options > General tab > Management Tool** or through your browser by typing your system name followed by :8080. For ex.: http://ivu:8080
- You enable the Alarm Notification Client on the **System Options > General** tab.
- The CCN/IP and BACnet/IP ports have to be exposed if the connection between the i-Vu® web server and the routers contain a firewall.
- All other ports are not configurable.

Communicating using PuTTY

You can connect a computer to a controller's Local Access port and then use PuTTY, a free open source terminal emulation program, to:

- Set the baud rate for ports S1 or S2 on the i-Vu® CCN Router, i-Vu® Link, i-Vu® Open Router, or i-Vu® Open Link
- Set controller properties, such as IP address and network information
- Retrieve a Modstat

PREREQUISITES

- A computer with a USB port
- A USB Link cable
NOTE The USB Link driver is installed with an i-Vu® v5 or later system. But if needed, you can get the latest driver from <http://www.silabs.com/products/mcu/Pages/USBtoUARTBridgeVCPDrivers.aspx>. Install the driver before you connect the USB Link to your computer.

⚠ CAUTION If multiple controllers share power but polarity was not maintained when they were wired, the difference between the controller's ground and the computer's AC power ground could damage the USB Link and the controller. If you are not sure of the wiring polarity, use a USB isolator between the computer and the USB Link. Purchase a USB isolator online from a third-party manufacturer.

- 1 Download and install PuTTY from the *PuTTY website* (<http://www.chiark.greenend.org.uk/~sgtatham/putty/download.html>).
- 2 Connect the laptop to the local access port of the controller, ZS sensor, or an SPT sensor using the USB Link cable(s).

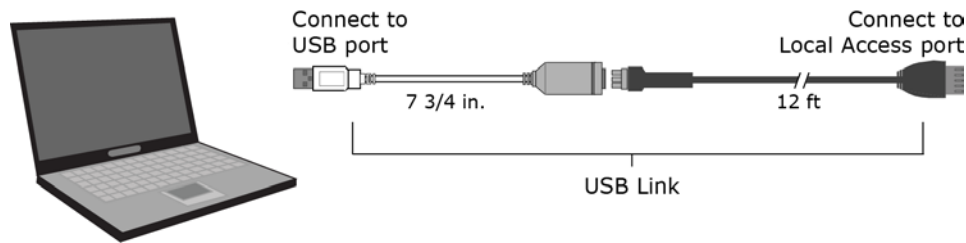

NOTE If using a USB isolator, plug the isolator into your computer's USB port, and then plug the USB Link cable into the isolator.

- 3 To change a router's IP address, subnet mask, or default gateway, set its **IP Address** DIP switch to **Assigned**.
- 4 Start PuTTY.
- 5 Under **Category > Connection**, select **Serial**.
- 6 Under **Options controlling local serial lines**, enter the following settings:

Field	Value
Serial line to connect to	Replace X with the computer's port number that the USB Link Kit cable is connected to. NOTE To find the port number, select Start > Control Panel > System > Device Manager > Ports (Com & LPT) . The COM port number is beside Silicon Labs CP210x USB to UART Bridge .
Speed (baud)	115200

Data Bits	8
Stop Bits	1
Parity	None
Flow Control	None

- 7 Click **Open**. A window similar to the one below appears.

```

BACnet Router, Ethernet MAC address = 00-E0-C9-00-4E-B8
1) Restart
2) Display Modstat
3) IP Address [192.168.168.1]
4) Subnet Mask [255.255.255.0]
5) Default Gateway [0.0.0.0]
6) BACnet/IP UDP Port [0xBAC0]
7) BACnet/IP Network [4824+]
8) BACnet/Ethernet Network [4829]
9) BACnet/ARCNET Network [4825]
10) BACnet/MSTP Network [4834]
11) Display B/IP PAD Table
12) Add B/IP PAD Table Entry
13) Delete B/IP PAD Table Entry
14) Clear B/IP PAD Table
15) Set baud rate for MSTP [76800]
16) Set baud rate for PTP [38400]

+ The HOME network is updated each time a network number
  is changed (#7-10).

Enter selection: _

```

- 8 Do one of the following:
- To change a property value:
 - a. Type the number of the property, then press **Enter**.
 - b. Type the new value, then press **Enter**.
 - To take an action, type number number of the action, then press **Enter**.
- 9 If you changed a value, type 1, then press **Enter** to restart the controller.
- 10 Close PuTTY.

Communicating using HyperTerminal

You can connect a computer to a controller's Local Access port and then use HyperTerminal, an application installed with Windows XP and older operating systems, to:

- Set the baud rate for ports S1 or S2 on the i-Vu® CCN Router, i-Vu® Link, i-Vu® Open Router, or i-Vu® Open Link
- Set controller properties, such as IP address and network information
- Retrieve a Modstat

PREREQUISITES

- A computer with a USB port
- A USB Link cable

NOTE The USB Link driver is installed with an i-Vu® v5 or later system. But if needed, you can get the latest driver from <http://www.silabs.com/products/mcu/Pages/USBtoUARTBridgeVCPDrivers.aspx>. Install the driver before you connect the USB Link to your computer.

CAUTION If multiple controllers share power but polarity was not maintained when they were wired, the difference between the controller's ground and the computer's AC power ground could damage the USB Link and the controller. If you are not sure of the wiring polarity, use a USB isolator between the computer and the USB Link. Purchase a USB isolator online from a third-party manufacturer.

- 1 Connect the computer to the local access port of the controller, ZS sensor, or an SPT sensor using the USB Link cable(s).

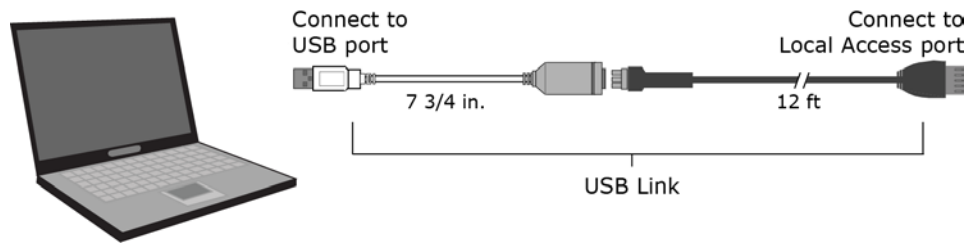

NOTE If using a USB isolator, plug the isolator into your computer's USB port, and then plug the USB Link cable into the isolator.

NOTE If using a USB isolator, plug the isolator into your computer's USB port, and then plug the USB Link cable into the isolator.

- 2 Verify that the baud rate is set to 115,200.
- 3 To change a router's IP address, subnet mask, or default gateway, set its **IP Address** DIP switch to **Assigned**.
- 4 Start Windows HyperTerminal located under **Start > Programs > Accessories > Communications**.
- 5 **NOTE** This option is not available in Windows v7 or later. You can download it from the Internet.
- 6 Select an icon for this connection file, then click **OK**.
- 7 In the **Connect to** dialog box, set the **Connect using** field to **ComX**, where **X** is the number of the computer's Com port that the USB Link cable is connected to, then click **OK**.
- 8 In the **Com Properties** dialog box, set the **Port Settings** for your local access port, then click **OK**.

Port Setting	Value
Bits per second	i-Vu® Open Link or i-Vu® Open Router 115200 i-Vu® Link or i-Vu® CCN Router
Data Bits	8

Parity	None
Stop Bits	1
Flow Control	None

- 1 From the main HyperTerminal screen, press **Enter** to view a router configuration screen like the one below.

```

BACnet Router, Ethernet MAC address = 00-E0-C9-00-4E-B8
1) Restart
2) Display Modstat
3) IP Address [192.168.168.1]
4) Subnet Mask [255.255.255.0]
5) Default Gateway [0.0.0.0]
6) BACnet/IP UDP Port [0xBAC0]
7) BACnet/IP Network [4824+]
8) BACnet/Ethernet Network [4829]
9) BACnet/ARCNET Network [4825]
10) BACnet/MSTP Network [4834]
11) Display B/IP PAD Table
12) Add B/IP PAD Table Entry
13) Delete B/IP PAD Table Entry
14) Clear B/IP PAD Table
15) Set baud rate for MSTP [76800]
16) Set baud rate for PTP [38400]

+ The HOME network is updated each time a network number
  is changed (#7-10).

Enter selection: _

```

- 2 Do one of the following:
 - o To change a property value:
 - a. Type the number of the property, then press **Enter**.
 - b. Type the new value, then press **Enter**.
 - o To take an action, type number number of the action, then press **Enter**.
- 3 If you changed a value, type 1, then press **Enter** to restart the controller.
- 4 Close HyperTerminal.

Document revision history

Important changes to this document are listed below. Minor changes such as typographical or formatting errors are not listed.

Date	Topic	Change description	Code*
8/4/14	Using TCP/UDP ports	Added CCN port information	C-TS-OC-E

* For internal use only



CARRIER CORPORATION ©2014

A member of the United Technologies Corporation family · Stock symbol UTX · Catalog No. 11-808-494-01 · 8/4/2014